

Product Manual

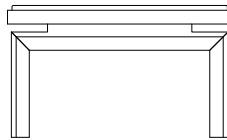
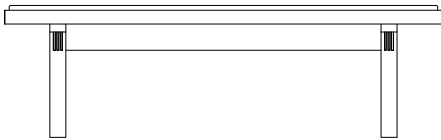

Stone Top for Elton Coffee Table Designed by Glismand & Rüdiger

Version 001 - May/2023

Bolia.com

Vaerkmestergade 11-13
8000 Aarhus C, Denmark
+45 51 50 51 22

EN

Read the product manual carefully before using your product. If you do not follow the instructions, there is a risk that you could damage the product or in the worst case cause injury. Keep the product manual for future reference. If the product is later passed on to third parties, this manual must also be provided.



This symbol indicates a warning regarding the care, handling, or use of the product. If such a warning is not followed, there is a risk that you could damage the product, or in the worst case cause injury.

Use the product only for the purpose described in this manual. Any other use does not correspond to the intended purpose of the product and can lead to damage to the product or injuries. The manufacturer or dealer accepts no responsibility for damage resulting from the use of the product in a manner for which it is not intended. Incorrect, improper use of the product can lead to personal injuries. Children must not play with the packaging film, as there is a risk that they will be wrapped up in it and caught. Before using the product, make sure that there is nothing that can harm or injure people.

Risk of damaging the product

Incorrect, improper use, handling and cleaning can damage parts or the entire product.

Do not step on or jump on the product. It is not intended for this.

Do not use a hard brush, solvent, corrosive or strong cleaning agent to clean the products, if not advised by Bolia.com.

Always use recommended care and cleaning products.

Never cover wet products. If a wet product is covered, it can be damaged.

Further information can be found on our website: Bolia.com

Technical information

As we are constantly developing and improving our products, design and technical changes may occur. This products manual can be downloaded as a PDF file from our website: Bolia.com



FR

donnez ou recyclez
votre produit



Association

ou



Magasin

ou



Déchèterie

Disposal of packaging & product

Dispose of the product and packaging in accordance with local waste regulations.

Packaging materials must be separated and disposed of properly.

For user instructions in other languages,
please scan this code





- GB:** Do not lift at the edge – or it may break. Support from below when lifting
DK: Løft ikke i kanten – det kan knække den. Understøt nedefra, når der løftes.
DE: Nicht am Rand anheben – das Produkt könnte brechen. Beim Anheben von unten abstützen.
NO: Ikke løft i kanten – den kan brette. Støtt fra undersiden ved løfting.
SE: Lyft inte i kanten – den kan gå sönder. Stötta underifrån vid lyft.
NL: Niet optillen aan de rand – anders kan het breken. Ondersteun van onderaf bij het optillen.
FR: Ne pas soulever par le bord, sous peine de le casser. Soutenir par le bas lors du levage.
ES: No elevar sujetando por el borde, ya que podría romperse. Al elevar, sujetar por abajo.



- GB:** This product is only for indoor use.
DK: Dette produkt er kun til indendørs brug.
DE: Dieses Produkt darf nur in Innenräumen verwendet werden.
NO: Dette produktet er kun ment for innendørs bruk.
SE: Den här produkten är endast avsedd för inomhusbruk.
NL: Dit product is uitsluitend bedoeld voor gebruik binnenshuis.
FR: Ce produit est uniquement destiné à un usage intérieur.
ES: Aquest producte només es pot fer servir a l'interior.

Fittings and product parts

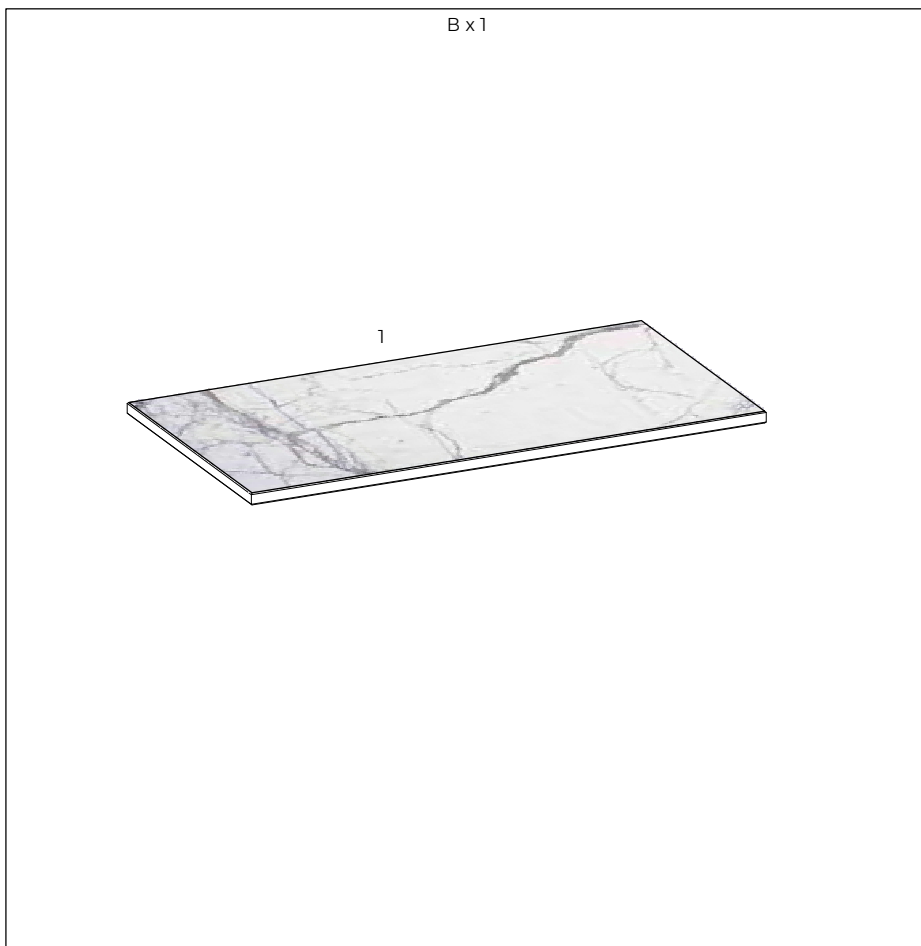
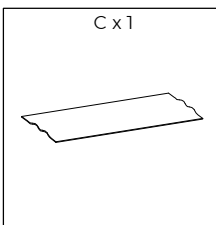
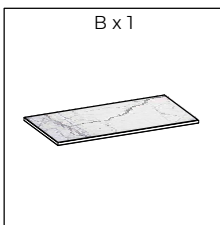
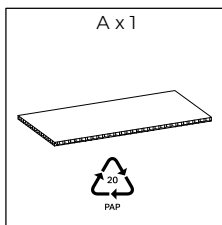

STEP 01

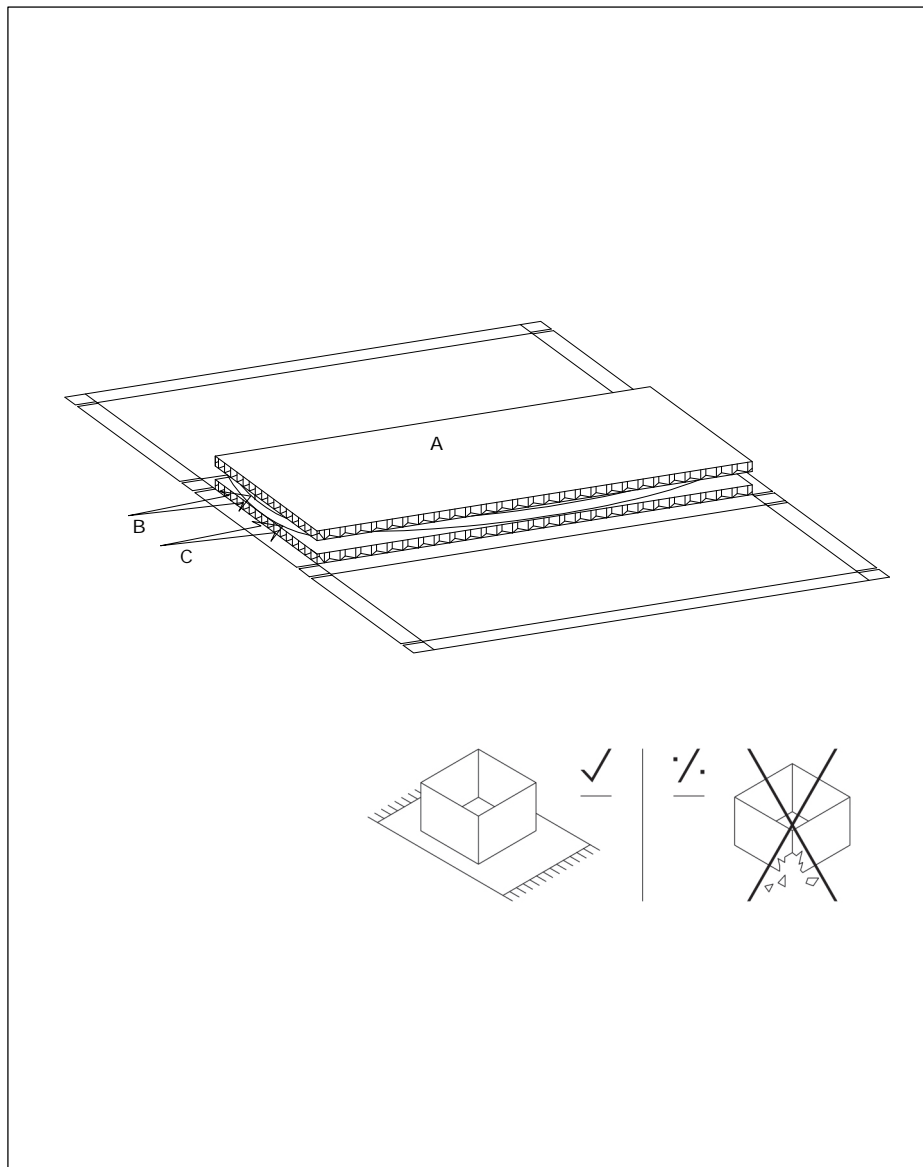

STEP 02

Tools & Special requirements

