

# Product Manual

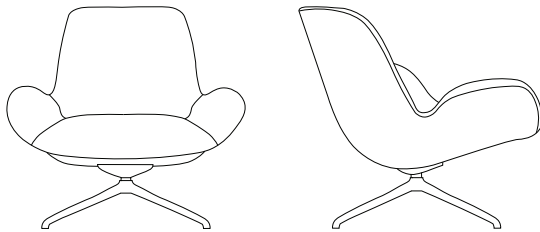

## Seed Lounge Chair Series Designed by Hans Thyge & Co

Version 001- 01/2025

### **BOLIA**

Vaerkmestergade 11,1  
8000 Aarhus C, Denmark  
+45 51 50 51 22

EN

Read the product manual carefully before using your product. If you do not follow the instructions, there is a risk that you could damage the product or in the worst case cause injury. Keep the product manual for future reference. If the product is later passed on to third parties, this manual must also be provided.



This symbol indicates a warning regarding the care, handling, or use of the product. If such a warning is not followed, there is a risk that you could damage the product, or in the worst case cause injury.

Use the product only for the purpose described in this manual. Any other use does not correspond to the intended purpose of the product and can lead to damage to the product or injuries. The manufacturer or dealer accepts no responsibility for damage resulting from the use of the product in a manner for which it is not intended. Incorrect, improper use of the product can lead to personal injuries. Children must not play with the packaging film, as there is a risk that they will be wrapped up in it and caught. Before using the product, make sure that there is nothing that can harm or injure people.

#### Risk of damaging the product

Incorrect, improper use, handling and cleaning can damage parts or the entire product.

Do not step on or jump on the product. It is not intended for this.

Do not use a hard brush, solvent, corrosive or strong cleaning agent to clean the products, if not advised by Bolia.com.

Always use recommended care and cleaning products.

Never cover wet products. If a wet product is covered, it can be damaged.

Further information can be found on our website: [Bolia.com](https://Bolia.com)

#### Technical information

As we are constantly developing and improving our products, design and technical changes may occur. This products manual can be downloaded as a PDF file from our website: [Bolia.com](https://Bolia.com)



#### Disposal of packaging & product

Dispose of the product and packaging in accordance with local waste regulations.

Packaging materials must be separated and disposed of properly.

For user instructions in other languages,  
please scan this code



## Warnings

---



**GB:** DANGER OF TIPPING OVER – do not use furniture as a climbing assist

**DK:** FARE FOR AT VÆLTE – brug ikke møbler som klatrehjælp

**DE:** KIPPGEFAHR – Möbel nicht als Aufstiegshilfe verwenden

**NO:** VELTEFARE – ikke bruk møblene som klatrehjelp

**SE:** TIPPRISK – använd inte möbler som klättringshjälp

**NL:** KANTELGEVAAR – gebruik meubels niet als

**FR:** RISQUE DE BASCULEMENT – ne pas utiliser les meubles comme accessoires pour grimper ou accéder à des objets en hauteur

**ES:** PELIGRO DE VUELCO: no utilices los muebles como ayuda para alcanzar zonas a alturas elevadas.

## Warnings

---



**GB:** Tested for 110 kg/242 lbs.

**DK:** Testet til 110 kg/242 lbs.

**DE:** Geprüft auf 110 kg.

**NO:** Testet for 110 kg/242 lbs.

**SE:** Testad för 110 kg.

**NL:** Getest voor 110 kg/242 lbs.

**FR:** Testé pour 110 kg/242

**ES:** Probado para 110 kg.

## Use of the product

---

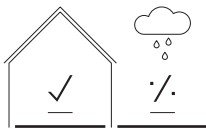

**GB:** This product is only for indoor use.

**DK:** Dette produkt er kun til indendørs brug.

**DE:** Dieses Produkt darf nur in Innenräumen verwendet werden.

**NO:** Dette produktet er kun ment for innendørs bruk.

**SE:** Den här produkten är endast avsedd för inomhusbruk.

**NL:** Dit product is uitsluitend bedoeld voor gebruik binnenshuis.

**FR:** Ce produit est uniquement destiné à un usage intérieur.

**ES:** Aquest producte només es pot fer servir a l'interior .

Tools overview

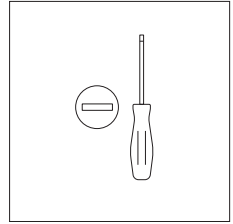
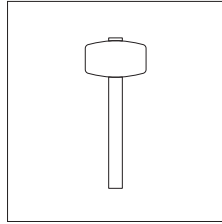
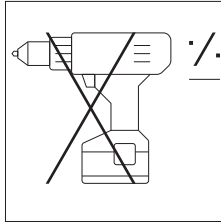
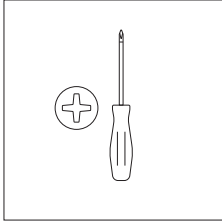

Disassembly steps

---

**STEP 01**

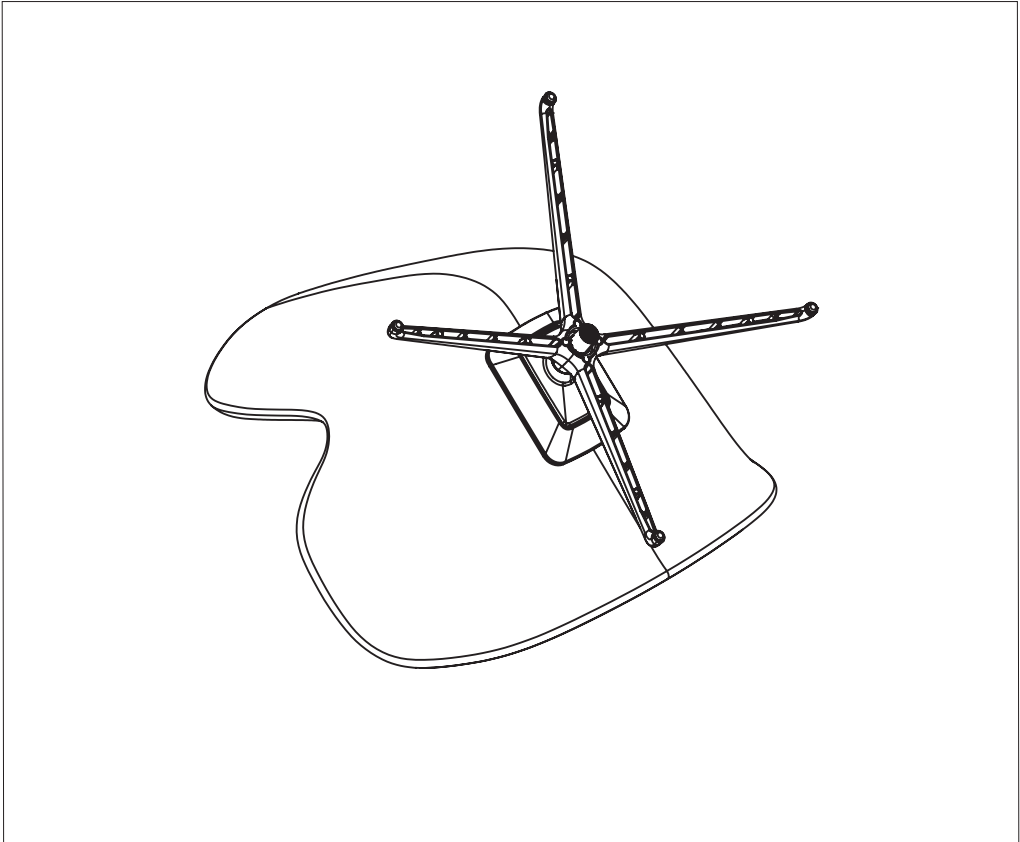

**STEP 02**

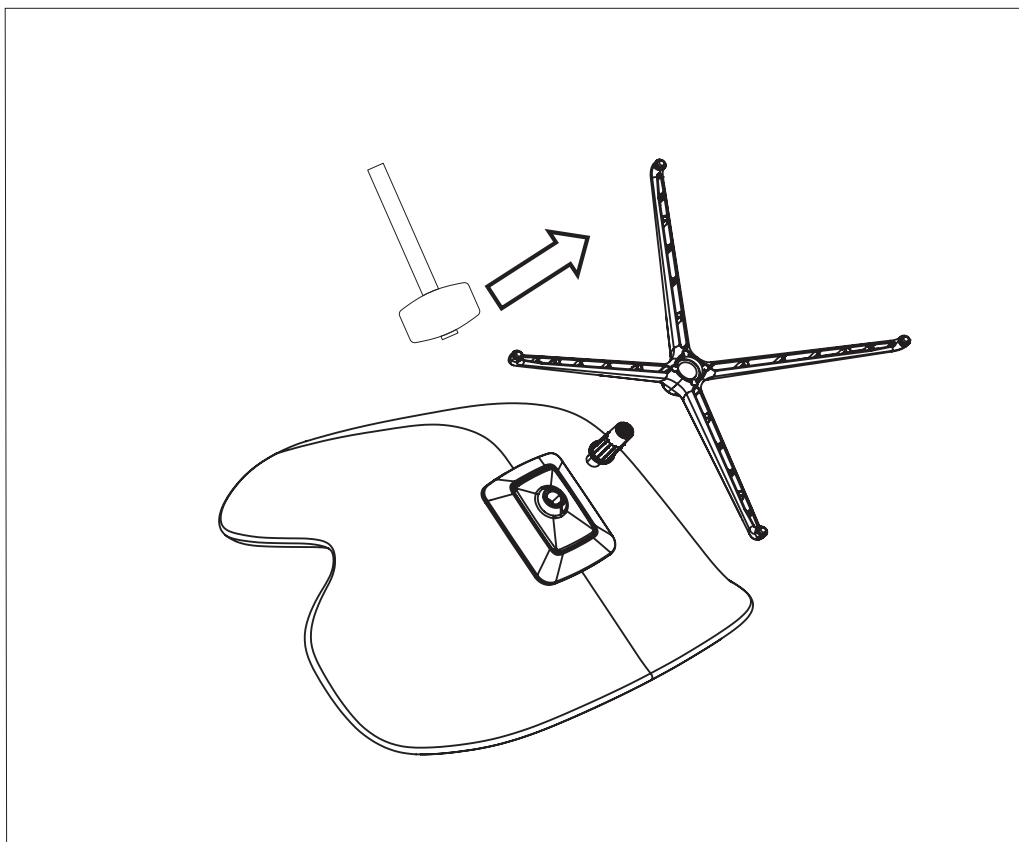
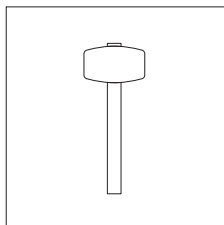

**STEP 03**

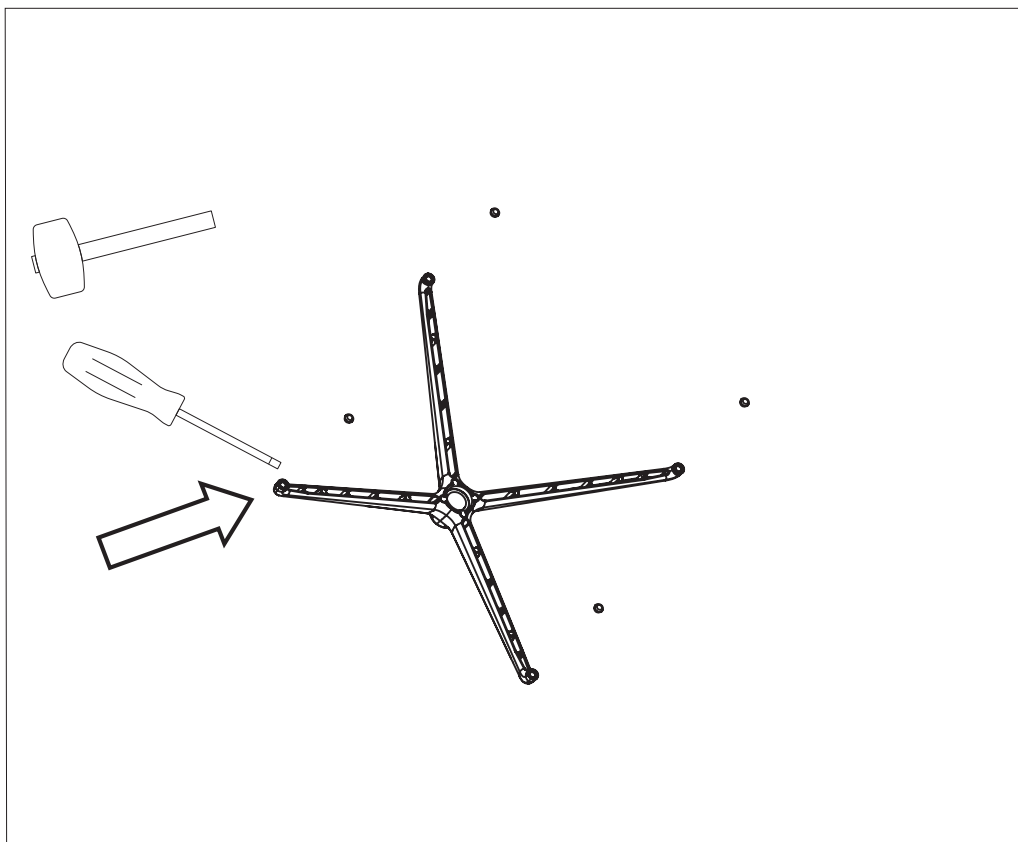
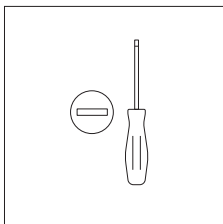
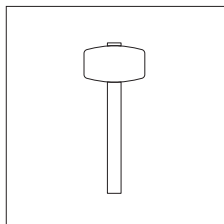

**STEP 04**

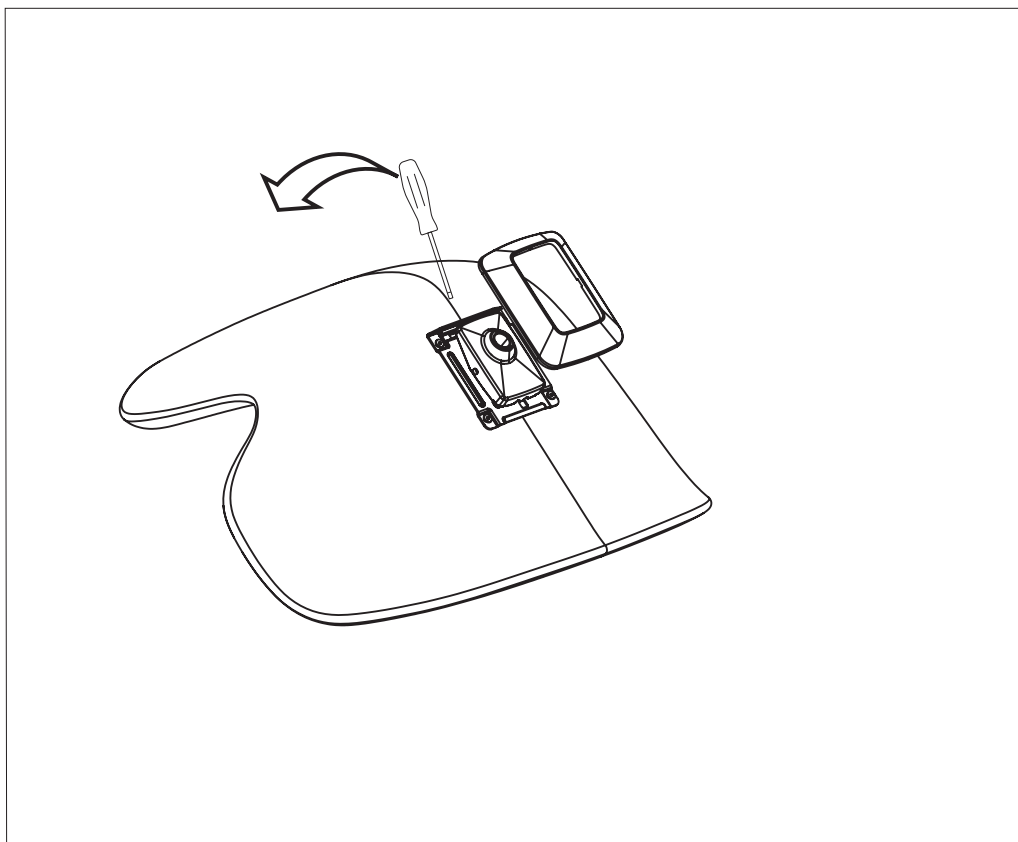
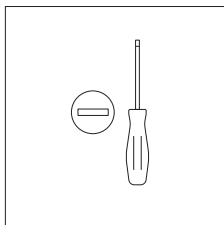

**STEP 05**

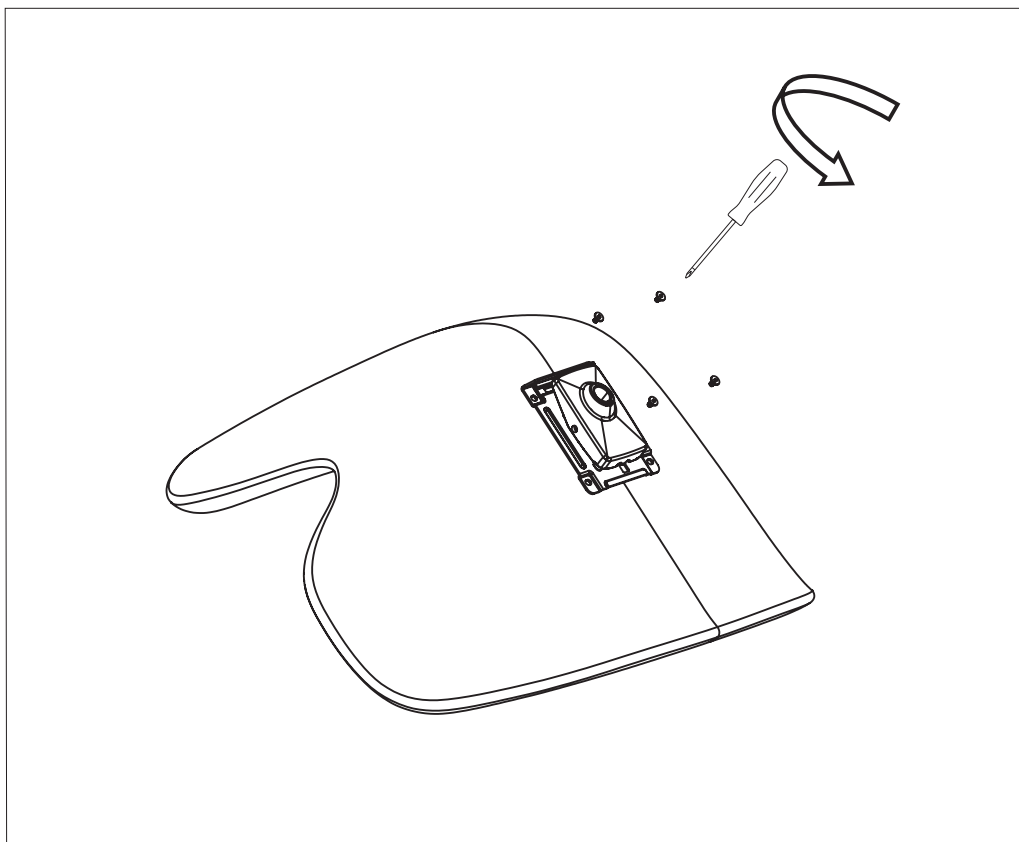
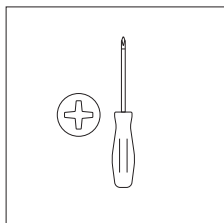

**STEP 06**

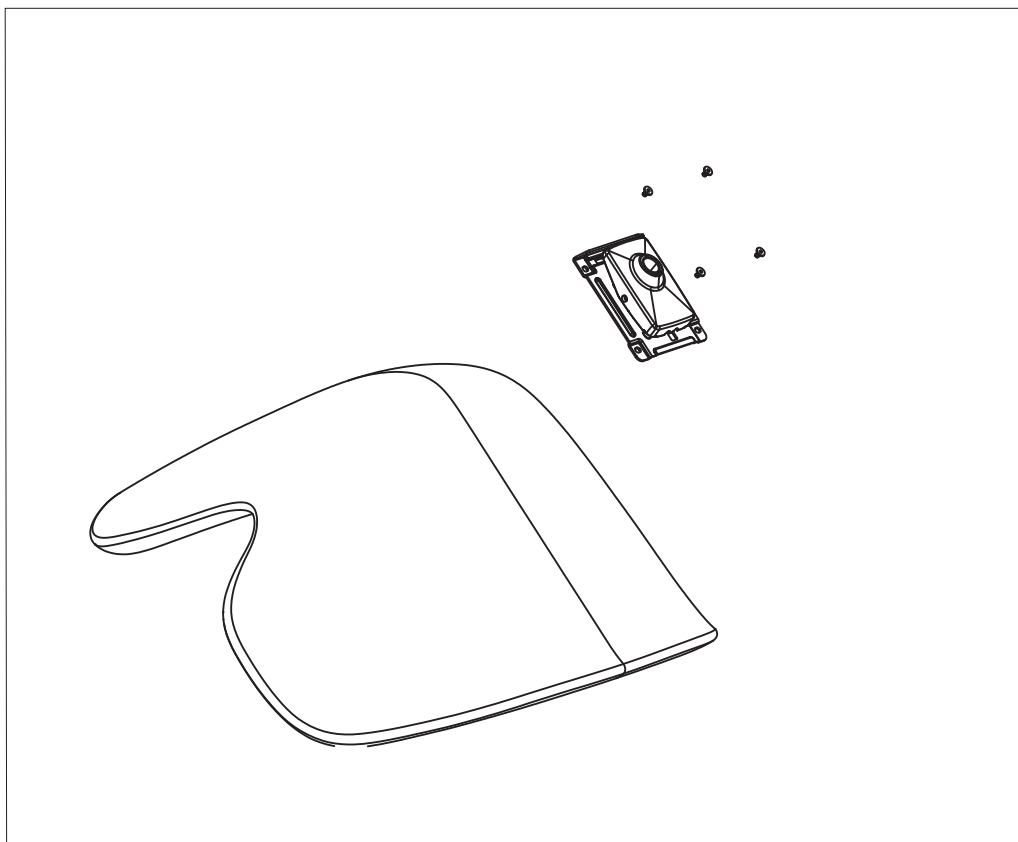

---

Max  
110 kg  
242 lb



**BOLIA**